



GEN II CANsmart™ Controller

DNL.WHS.24900
 Yamaha Tenere 700
 Standard, World Raid, Rally Edition,
 Extreme Edition, Explore Edition

Thank you for choosing DENALI

We know you would rather be riding your bike than wrenching on it, so we go the extra mile to make sure our instructions are clear and as easy to understand as possible. If you have any questions, comments, or suggestions don't hesitate to give our experts a call at 401.360.2550 or visit WWW.DENALIELECTRONICS.COM

Please Read Before Installing

DENALI products should always be installed by a qualified motorcycle technician. If you are unsure of your ability to properly install a product, please have the product installed by your local motorcycle dealer. DENALI takes no responsibility for damages caused by improper installation. **Caution:** When installing electronics it is extremely important to pay close attention to how wires are routed, especially when mounting products to the front fender, front fork, or fairing of your motorcycle. Always be sure to turn the handlebars fully left, fully right, and fully compress the suspension to ensure the wires will not bind and have enough slack for your motorcycle to operate properly.

Installation Tips

We strongly recommend using medium strength liquid thread locker on all screws and bolts. It is also important to ensure that all hardware is tightened to the proper torque specifications as listed in your owner's manual. For included accessory hardware please refer to the default torque specifications provided below. Inspect all hardware after the first 30 miles to ensure that proper torque specifications are maintained.

Bolt Size	in-lbs	ft-lbs	Nm
M3	10.0 in-lbs	-	1.0 Nm
M4	23.0 in-lbs	-	2.5 Nm
M5	44.5 in-lbs	3.5 ft-lbs	5.0 Nm
M6	78.0 in-lbs	6.5 ft-lbs	9.0 Nm
M8	-	13.5 ft-lbs	18.0 Nm
M10	-	30.0 ft-lbs	41.0 Nm
M12	-	52.0 ft-lbs	71.0 Nm

Hardware Sizing Guide

Not sure what size bolt you have? Use this ruler to measure screws, bolts, spacers, etc. Remember, the length of a screw or bolt is measured from the start of the "mounting surface" to the end of the screw, so only include the screw head when measuring countersunk screws.

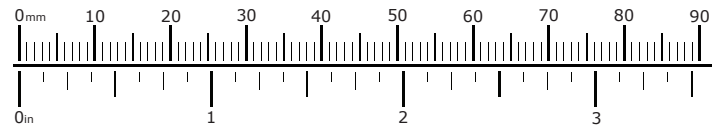

What's In The Box?

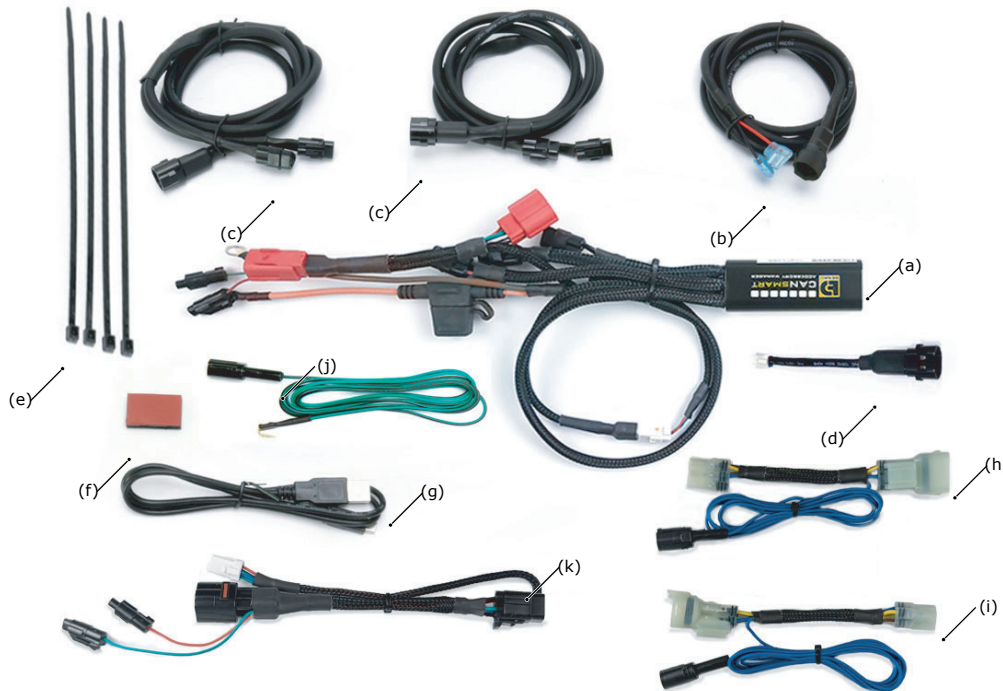

Kit Contents

- (a) CANsmart™ Controller (DNL.WHS.113).....Qty 1
- (b) 3-Pin 5ft Horn Extension (DNL.WHS.066).....Qty 1
- (c) 3-Pin 5ft LED Light Extension (DNL.WHS.018).....Qty 2
- (d) 3-Pin Brake Light Wiring Adapter (DNL.WHS.067).....Qty 1
- (e) Zip Tie.....Qty 4
- (f) Adhesive Dual Lock.....Qty 1

- (g) USB to Micro USB Programming Cable.....Qty 1
- (h) Headlight Pass Through (T7 with TFT Display).....Qty 1
- (i) Headlight Pass Through (T7 with LCD Display).....Qty 1
- (j) Horn Input Harness.....Qty 1
- (k) EURO 4 Adapter Harness.....Qty 1

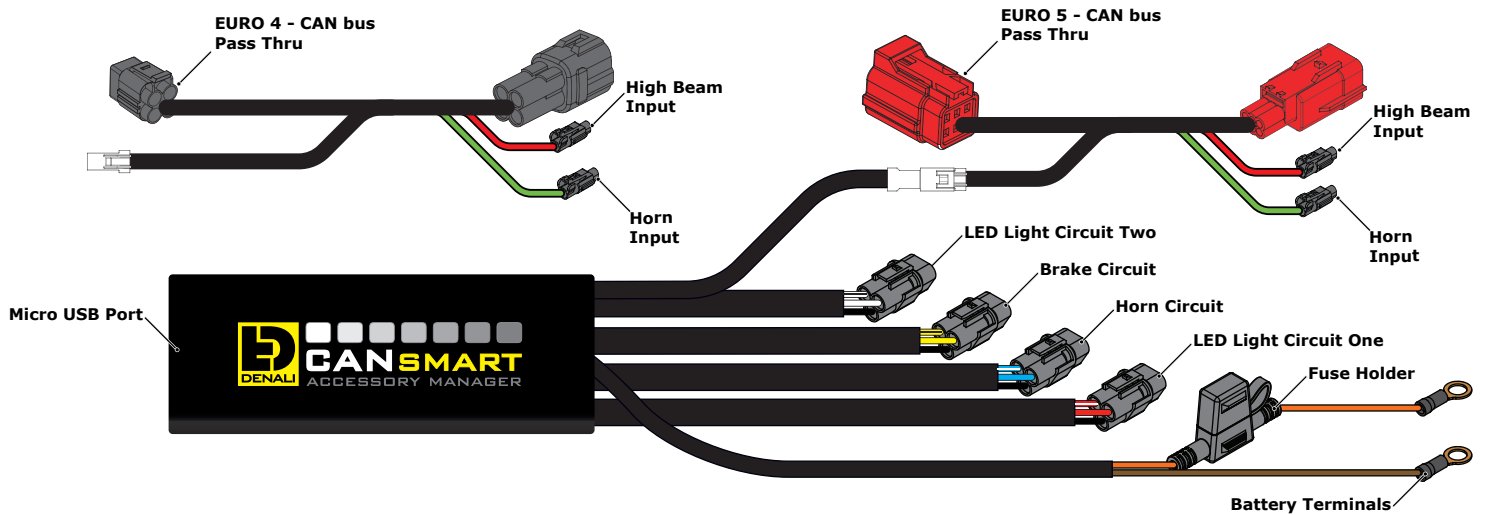

1.1 - Overview of Device

The DENALI CANsmart™ Controller provides plug-n-play installation and integrated control of up to four accessories to enable dozens of customizable settings that can be controlled right from the Vehicles Controller or the CANsmart™ Accessory Manager Software.

The four circuits are pre-programmed to connect and independently control two sets of DENALI 2.0 lights, a SoundBomb horn, and our B6 auxiliary brake light. However, our Circuit Function Selector in the CANsmart software will let you run any accessory of your choice on any of the four circuits.

The CANsmart™ Controller for Ténéré 700 supports both EURO 4 and EURO 5 compliant vehicles, by including their respective pass through connectors.

The illustration above depicts the preprogrammed default configuration, to see all available circuit functions and settings please refer *Section 6* or visit our online user guide at: DENALIElectronics.com/cansmart-user-guide

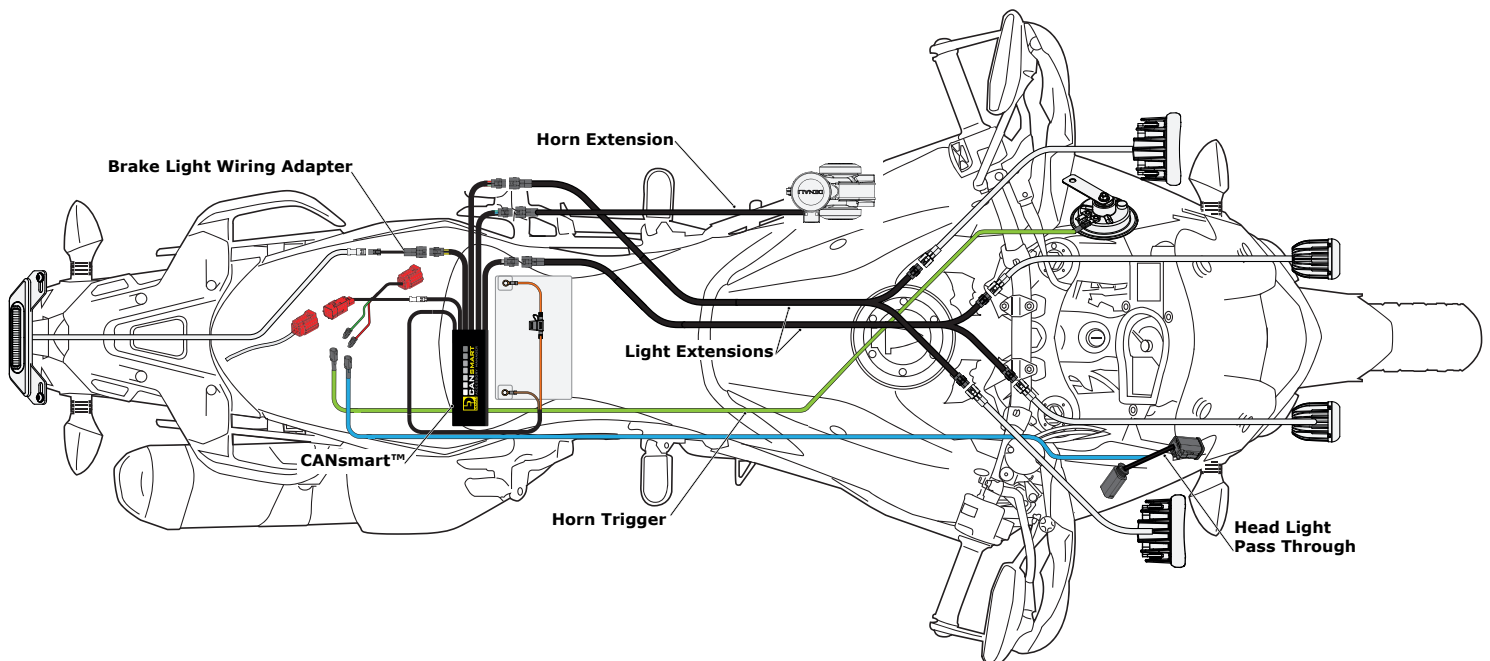

1.2 - Overview of System Features

The CANsmart™ for Yamaha Ténéré features a “flash to pass” and “strobe when horn active” setting that will strobe the auxiliary lights when you pulse your high beam switch or sound your horn.

Auxiliary Light Circuit One can be adjusted right from the vehicle’s factory controls while Circuit Two mimics Circuit One’s on/off state and dims independently through the software.

The feature-rich brake light circuit will transform a simple 2-wire brake light into a “smart brake light” complete with running light, multiple flash patterns, and deceleration activated braking functionality.

For a full list of features and available settings refer to *Section 6*.

2. Connecting To CAN bus

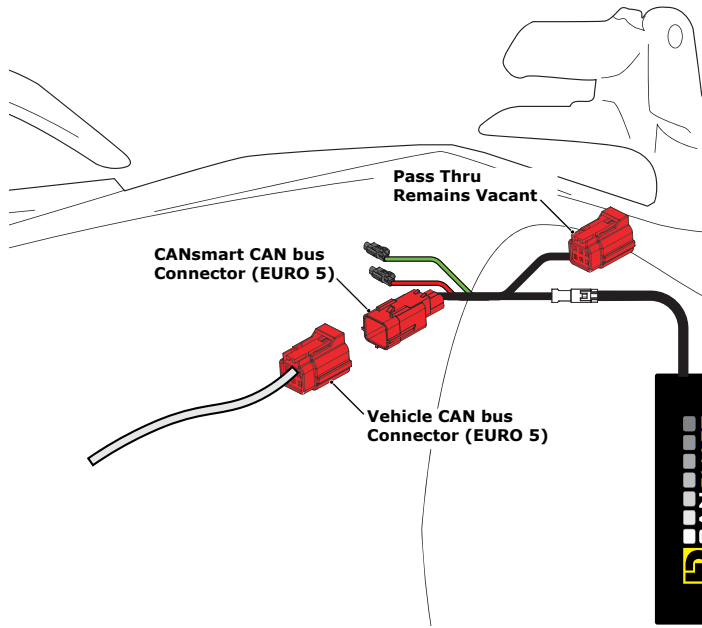

2.1a - Connecting To The CAN bus (EURO 5)

When the Ténéré transitioned from EURO 4 to EURO 5 regulations, the diagnostics ports had to change respectively. Depending on the production date of your vehicle, it will have either a EURO 4 or EURO 5 diagnostics port. This kit includes both style connectors to ensure proper integration.

Step One: Locate your bike's EURO 5 Diagnostic Port. The port is a Red 6-Pin, diagnostic connector. In general the connector is located underneath the riders seat. For the exact location, check your bike's owners manual.

Step Two: Connect the vehicle's CAN bus connector to the CANsmart™ Controller. The Pass Thru connector is left vacant in the event of needing diagnostics access or to connect an additional accessory.

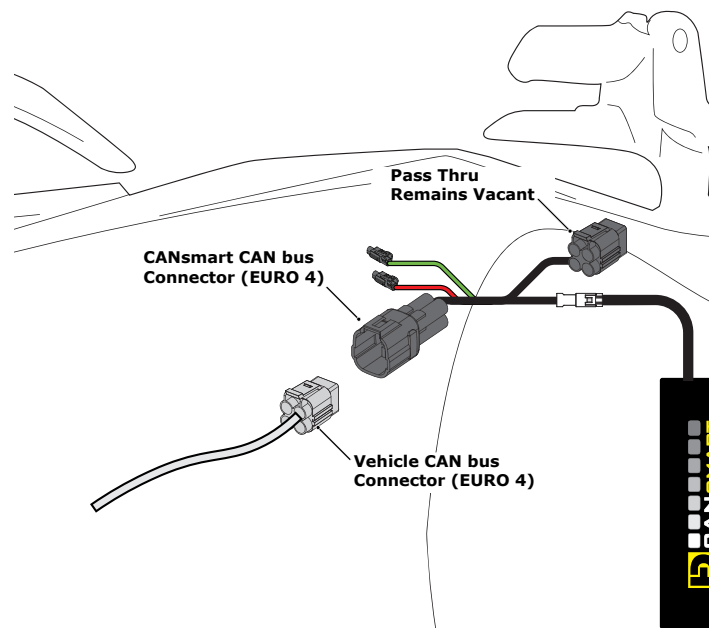

2.1b - Connecting To The CAN bus (EURO 4)

Step One: Locate your bike's EURO 4 Diagnostic Port. The port is a White 4-Pin, diagnostic connector. In general the connector is located underneath the riders seat. For the exact location, check your bike's owners manual.

Step Two: Connect the vehicle's CAN bus connector to the CANsmart™ Controller.

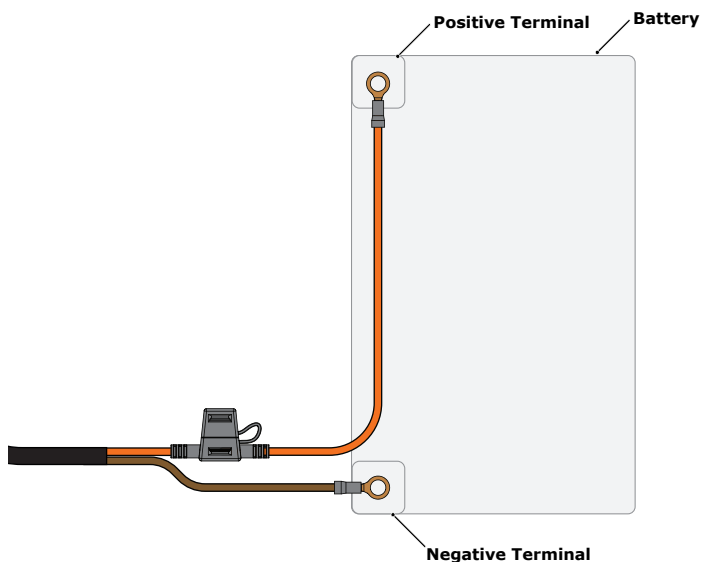

2.2 - Connecting To The Battery

Step One: Remove the fuse from the fuse holder.

Step Two: Gain access to the vehicle's battery and disconnect the negative (-) and positive (+) terminals.

Step Three: Connect the CANsmart™ wiring harness to the battery via the ring terminals. Be sure the orange wire lead with the fuse holder goes to the positive (+) terminal of the battery.

Step Four: Re-install the fuse into the fuse holder.

Note: Place the fuse holder in an easily accessible location for convenient service in the event of a blown fuse.

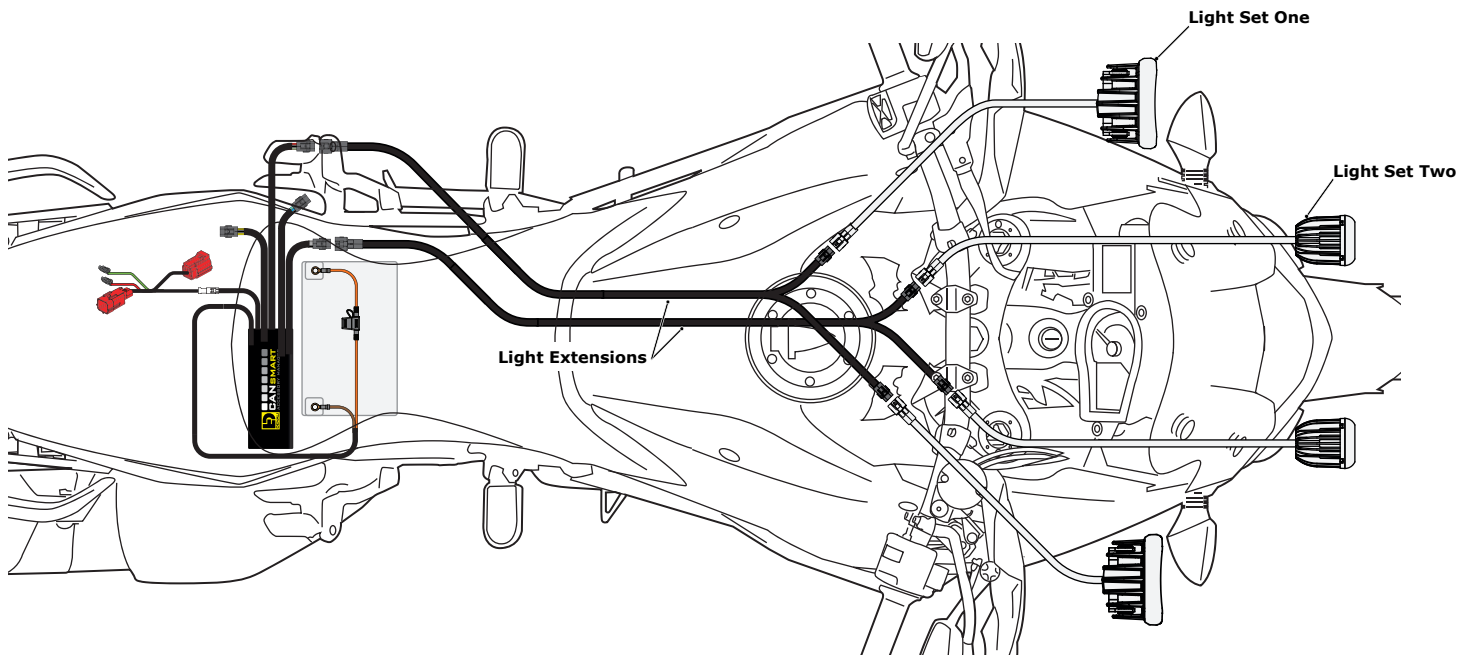

3.1 - Light Set One & Two (Red & White Circuits)

In the default configuration, the circuit for Light Set One is the longest red lead, the shortest white lead is for Light Set Two. Both circuits are designed to handle up to 10 amps each.

Step One: Plug the male 3-pin connector of the Light Extension-Splitter into one of the CANsmart™ Controller's light circuits.

Step Two: Begin routing the harness toward the front of the bike. Secure the harness to the vehicle's frame along the way with the included zip ties. Be sure to avoid any moving components such as radiator fan blades or suspension.

Step Three: Plug the DENALI Light Pods into the female 3-pin connectors of the Extension-Splitter. Repeat steps *One* through *Three* using a second Light Extension-Splitter for the second set of lights.

Two-Wire Dimming: Turn off "Three-Wire Dimming Mode" for correct dimming operation of auxiliary LED lights that have only two wires. If enabled the 3rd yellow wire will be deactivated and PWM data will instead be transmitted through the red wire.

Wire two wire lights using the red wire for positive (+) and the black wire for negative (-).

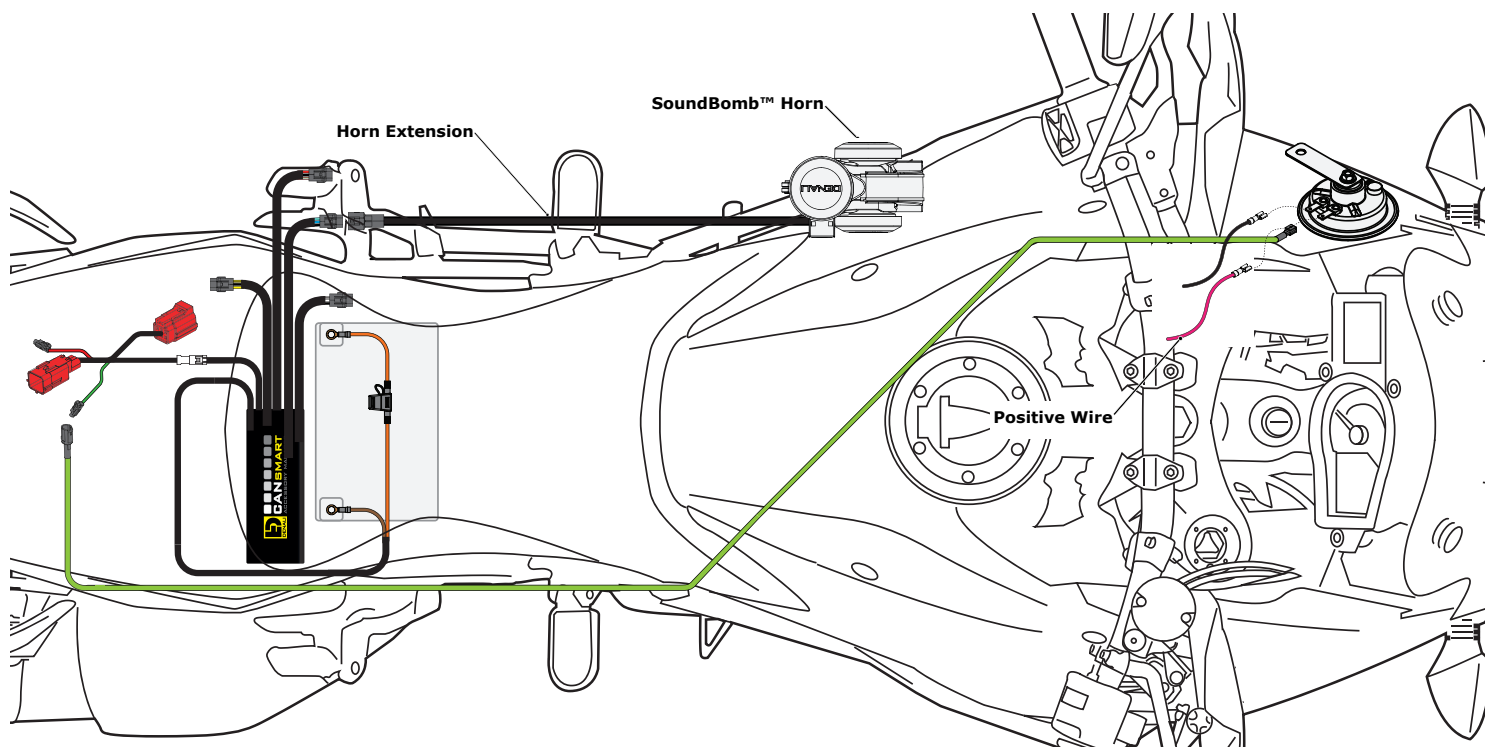

3.2 - Horn (Blue Circuit)

Step One: Plug the male 2-pin connector of the Horn Extension into blue horn circuit on the CANsmart™ Controller.

Step Two: Begin routing the harness toward the front of the bike. Secure the harness to the vehicle's frame along the way with the included zip ties. Be sure to avoid any moving components such as radiator fan blades or suspension.

Step Three: Plug the spade connectors of the Horn Extension into the DENALI SoundBomb Horn. The Green wire connects to the positive (+) terminal on the horn, the Black wire goes to the negative (-) terminal.

3.3 - Horn Input Harness (Green Wire)

Step One: Plug the 1-pin, Male connector of the Horn Input Harness into the green with black stripe horn input wire on the CANsmart™ Controller.

Step Two: Disconnect the horn positive wire from the factory horn.

Step Three: Connect the Horn Input Harness (j) to the factory horn positive terminal.

Step Four: Plug the horn positive wire into the piggy back terminal on the Horn Input Harness.

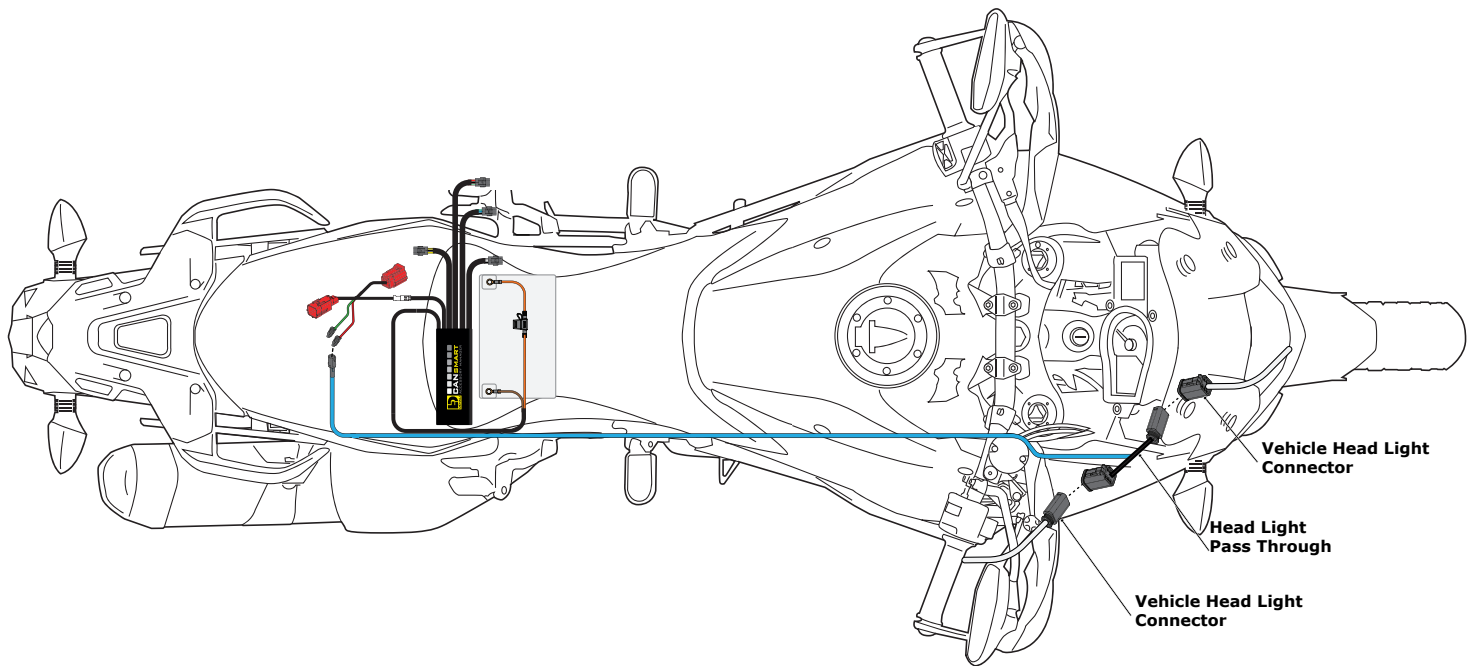

3.4 - Head Light Input Harness

Two Pass Through harnesses are included, one of which will be used to provide a High Beam signal to the CANsmart™. This allows your Auxiliary Lights to change brightness with High Beam.

The 4-Pin connector (h) is used on Ténéré models with TFT displays
The 6-Pin connector (i) is used on Ténéré models with LCD displays

Step One: Access the vehicle's head light connector, which is on the right side of the bike, behind the Front Turn Signal panel.

Step Two: Disconnect the vehicle head light connectors.

Step Three: Connect the appropriate Head Light Pass Through between the factory vehicle connectors.

Step Four: Route the blue wire back to the CANsmart™ and plug the 1-Pin Connector (Blue Wire) into the 1-Pin Connector (Red Wire) on the controller.

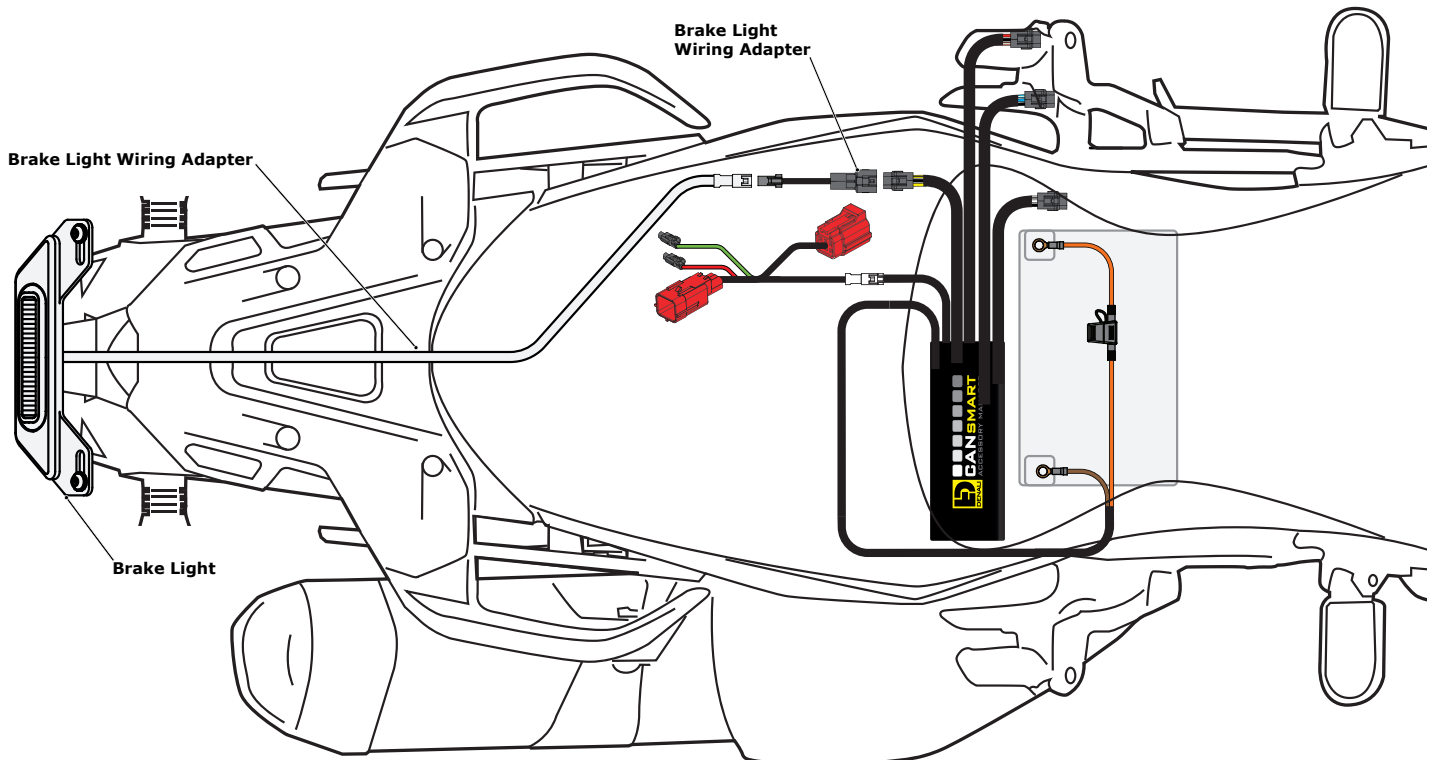

3.5 - Brake Light (Yellow Circuit)

Step One: Route the harness of the DENALI B6 Brake Light from the rear of your motorcycle toward the CANsmart™ Controller.



Step Two: Plug the Brake Light Pigtail into the connector on the DENALI B6 Brake Light.

Step Three: Plug the male 2-pin connector of the Brake Light Pigtail into the yellow brake light circuit on the CANsmart™ Controller.



Powered by
HEX INNOVATE



Circuit Functions Click on the icons to change the function of each circuit

● Red Circuit



LIGHT PAIR 1

● Blue Circuit



HORN

● Yellow Circuit















BRAKE LIGHT

○ White Circuit



LIGHT PAIR 2

 LEFT LIGHT 1	 RIGHT LIGHT 1	 LIGHT PAIR 1	 ACCESSORY	 HORN
 LEFT LIGHT 2	 RIGHT LIGHT 2	 LIGHT PAIR 2	 LEFT TURN	 RIGHT TURN
 BRAKE LIGHT	 BRAKE & TURN LEFT	 BRAKE & TURN RIGHT	 DISABLE CIRCUIT	 HEATED GEAR

10A continuous, 25A Maximum (for 25s) per circuit.
25A continuous current draw for the entire system

4.1 - Circuit Function Selector

The Circuit Function Selector in the CANsmart software will let you run any accessory of your choice on any of the four circuits. Click on a circuit icon to open the drop down menu and make your selection from the list of available circuit functions. Continue reading for an overview of each circuit function and its available settings.





Auxiliary Lights One ● ⋮



HIGH BEAM



LOW BEAM

	Day Intensity	<input style="width: 100%;" type="range"/>	100 %
	Night Intensity	<input style="width: 100%;" type="range"/>	100 %
	Day Intensity	<input style="width: 100%;" type="range"/>	50 %
	Night Intensity	<input style="width: 100%;" type="range"/>	50 %

- Off when turn signal active
- Strobe when Horn active
- Strobe on "Flash to pass"
- Inverse flashing when hazards active
- Modulation

Three-Wire Dimming Mode
Disable this mode for two-wire auxiliary LED lights

Not Available

4.2 - Auxiliary Lights One (Pair or Split)

Available settings include "Strobe when horn active", "Strobe on flash to pass", as well as "Modulation". "Three-Wire dimming mode" can be turned off to properly dim LED lights which do not have a dedicated 3rd dimming wire. From the extra settings window you can adjust the "Strobe Intensity" as well as the "Modulation variation".

Auxiliary Lights Two

High Beam: Day Intensity 100%, Night Intensity 100%

Low Beam: Day Intensity 50%, Night Intensity 50%

Off when turn signal active

Strobe when Horn active

Strobe on "Flash to pass"

Inverse flashing when hazards active

Modulation

Three-Wire Dimming Mode
Disable this mode for two-wire auxiliary LED lights

4.3 - Auxiliary Lights Two (Pair or Split)

Available settings include "Strobe when horn active", "Strobe on flash to pass", as well as "Modulation". "Three-Wire dimming mode" can be turned off to properly dim LED lights which do not have a dedicated 3rd dimming wire. From the extra settings window you can adjust the "Strobe Intensity" as well as the "Modulation variation".

Auxiliary Brake Light

Running Light Intensity 10%

Brake Light Intensity 100%

Solid on braking

Brake Applied Flashing (Continuous)

Brake Applied Flashing (California legal)

Flash on Emergency Stop

Flash on Rapid Engine Braking

4.4 - Auxiliary Brake Light

The feature-rich Auxiliary Brake Light circuit function will transform a simple 2-wire brake light into a "smart brake light" complete with running light, multiple flash patterns, and deceleration activated braking functionality. From the extra settings window you can also adjust the "Brake Flashing Travel Speed" as well as the "Deceleration activated braking sensitivity".

Auxiliary Horn

Horn enabled

4.5 - Auxiliary Horn

The horn circuit enables the addition of an auxiliary horn without having to add a relay and dedicated horn wiring harness.

Accessory / Ignition Supply

10 s Time-out

Accessory Power

4.6 - Accessory

The Accessory circuit function will provide simple switched 12v power to an accessory of your choice when the motorcycles ignition is turned on. Additionally a time-out can be set from 0-60 seconds, which determines how long the accessory circuit will remain on after the motorcycles ignition is turned off. The 3rd "data" wire always turns off instantly with ignition.

4.7 - Where To Download The Software

The CANsmart™ Accessory Manager Software is available for both Windows and Mac operating systems. To download your copy please visit WWW.DENALIELECTRONICS.COM/PAGES/CANSMART-SOFTWARE

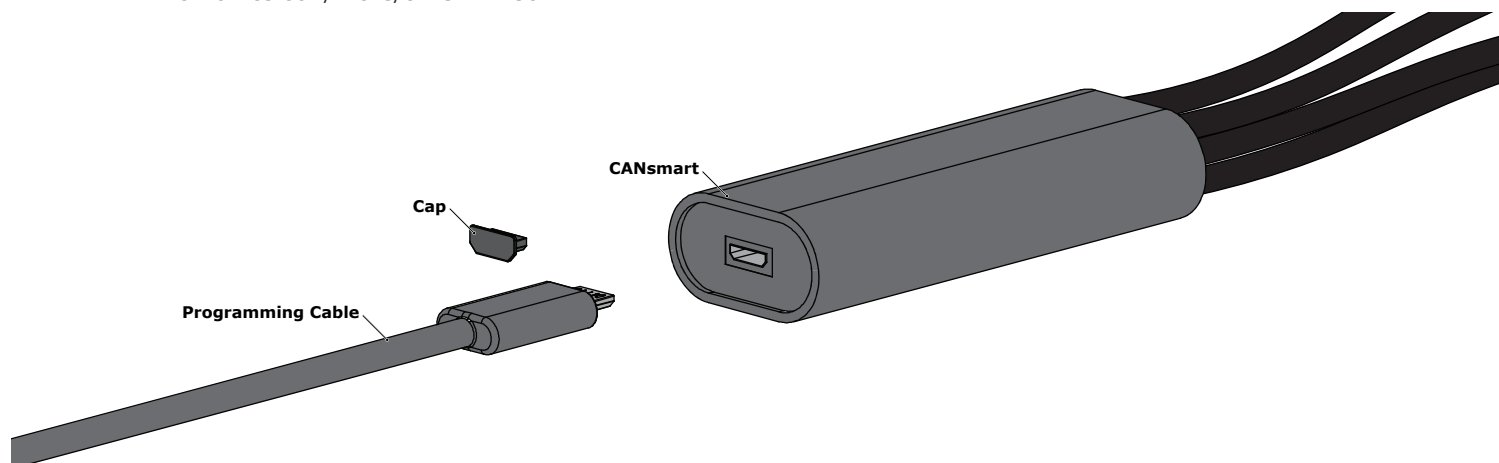

4.8 - Connecting The Device To The Software

Step One: Remove the protective cap from micro USB port on the end of the CANsmart™ Controller.

Step Two: Plug the provided programming cable into the CANsmart™ Controller, and plug the other end into your computers USB port.

Step Three: Open the CANsmart Accessory Manger Software and turn the motorcycle's ignition to the "ON" position.

5. Controlling Via The Motorcycle (Ténéré 700)

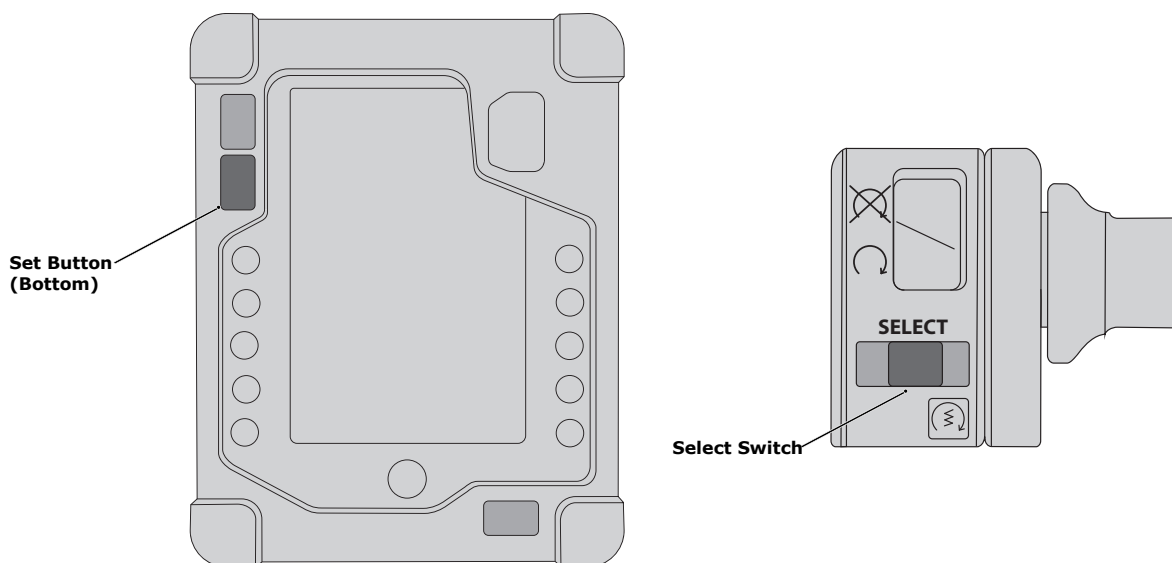

5.1 - Yamaha Ténéré Controls (LCD Dash Display)

Auxiliary Light One is controlled via the Bottom "Set" Button on the dash board **OR** the "Select" Switch on the Right Hand Controls. See the table below for Auxiliary Light Two control.

5.2 - Yamaha Ténéré 700 CANsmart Operation (LCD Dash Display)

Auxiliary Light Set One	
On/Off	Press & Hold the Bottom "SET" button until the lights fade off (If lights were on, they will flash first)
Enter Dimming Mode	Press & Hold the Bottom "SET" button until the AUX 1 Lights flash twice
Adjust Intensity	Tap the Bottom "SET" button to cycle between 0% to 100% in 10% increments. Cycle will go back to 0% after 100%.
Exit Dimming Mode	Wait for 5 seconds to time out
Auxiliary Light Set Two	
On/Off	Control through CANsmart Software only. Can be set to mimic Auxilliary Light Set One.
Adjust Intensity	Control through CANsmart Software only
Disable All Lights	
Turn Off (Resets with Ignition)	Press & Hold the Bottom "SET" button until the lights fade off + 5 seconds
Auxiliary Horn	
Sound Auxiliary Horn	Press vehicle's original horn button
Auxiliary Brake Light	
Activate Auxiliary Brake Light	Apply vehicles front or rear brakes (Can be set to flash upon deceleration)
Strobe Auxiliary Light	
Strobe	Click "Flash-to-Pass" button three times

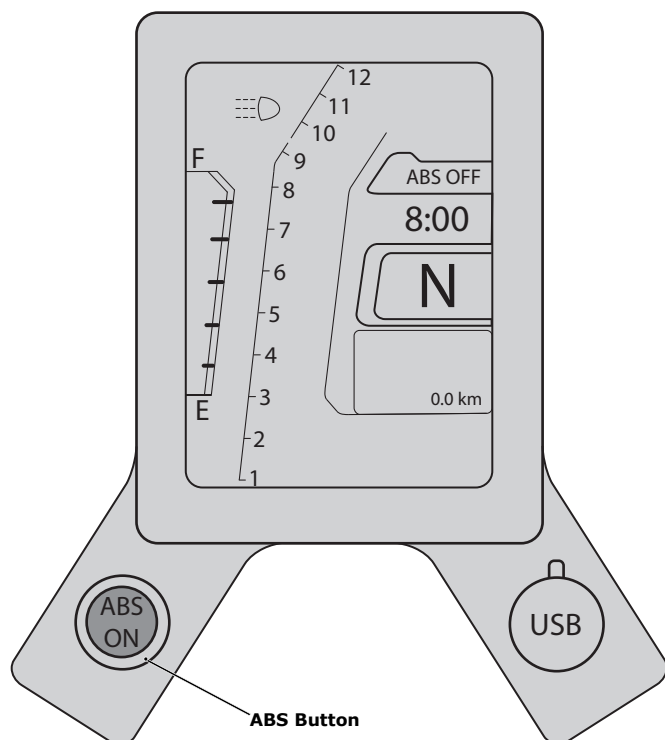

5.3 - Yamaha Ténéré Controls (Color TFT Dash Display)

Auxiliary Light One is controlled via the "ABS" Button that is adjacent to the TFT Dashboard display. See the table below for Auxiliary Light Two control.

5.4 - Yamaha Ténéré 700 CANsmart Operation (Color TFT Dash Display)

Auxiliary Light Set One	
On/Off	Press & Hold the Bottom "ABS ON" button until the lights fade off (If lights were on, they will flash first)
Enter Dimming Mode	Press & Hold the Bottom "ABS ON" button until the AUX 1 Lights flash twice
Adjust Intensity	Tap the Bottom "ABS ON" button to cycle between 0% to 100% in 10% increments. Cycle will go back to 0% after 100%.
Exit Dimming Mode	Wait for 5 seconds to time out
Auxiliary Light Set Two	
On/Off	Control through CANsmart Software only. Can be set to mimic Auxiliary Light Set One.
Adjust Intensity	Control through CANsmart Software only
Disable All Lights	
Turn Off (Resets with Ignition)	Press & Hold the Bottom "SELECT" button until the lights fade off + 5 seconds
Auxiliary Horn	
Sound Auxiliary Horn	Press vehicle's original horn button
Auxiliary Brake Light	
Activate Auxiliary Brake Light	Apply vehicles front or rear brakes (Can be set to flash upon deceleration)
Strobe Auxiliary Light	
Strobe	Click "Flash-to-Pass" button three times

Note: Due to variances with the Ténéré 700's factory wiring harness, the following limitations apply:

- Auxiliary Light TWO, independent Dimming and ON/OFF functions are not available from bikes factory controls (*Intensity must be set using software. ON/OFF may mimic Auxiliary Light One when set in the software.*)
- Turn signal circuit function not available.
- Cancel auxiliary lights with turn signal feature not available.
- Flash auxiliary lights as turn signal feature not available.
- Heated gear cannot be controlled using the Ténéré's
- Day/Night brightness differentiation is not available

Diagnostics
✕

Output Circuits

Red Circuit

Average: 0.00 A

Peak: 0.00 A

Blue Circuit

Average: 0.00 A

Peak: 0.00 A

Yellow Circuit

Average: 0.00 A

Peak: 0.00 A

White Circuit

Average: 0.00 A

Peak: 0.00 A

Output Circuit Test

Red Circuit

Blue Circuit

Yellow Circuit

White Circuit

Use the sliders to test circuits. Closing the diagnostics window will revert back to normal operation.

Horn and Accessory circuits can only be turned on at 100% intensity

System

Temperature

26.5 °C

Battery Voltage

0.00 V

Switch State

Open

Horn Input Voltage

0.00 V

CANBUS data

Inactive

Messages

Device not connected to battery. Please check connection and physical fuse.

No CAN bus data detected. This could be due to a faulty connection or ignition is off.

6.1 - Diagnostics Windows

The Diagnostics Window can be opened from the main menu. Use this window to get an overall view of the systems power consumption, as well as Battery/CAN bus voltage and device temperature.

Each circuit can be tested by sliding the slider underneath the circuit name. The unit must be connected to the battery or another source of 12V DC power in order to use the circuit test feature. The circuits will revert to normal operation when the diagnostics window is closed.

CANsmart™ Status Indicator Light Key

LED Color	Status	Solution
Solid Green	Normal operation, no errors present. (Vehicle Ignition ON)	N/A
Slow Flashing Green	Normal operation, no errors present. (Vehicle Ignition OFF)	N/A
Quick Flashing Green	Bootloader Mode (Should only be seen during firmware upgrade)	Connect to software, should reset into normal operation
Solid Red	Recovered from an unexpected failure	Connect to software, should attempt to reset to normal operation. Please report the exact circumstances to DENALI for analysis.
Flashing Red	At least one channels electronics fuse has been tripped.	Check/Increase fuse settings, cycle ignition to reset electronic fuses
Solid Green & Flashing Red	Application Firmware Corrupt	Connect to software, should offer an upgrade/recovery
Solid Red & Solid Green	Device has been deactivated	Return to DENALI for analysis. Please send log files info@DENALIElectronic.com for analysis by DENALI.
Flashing Red & Flashing Green	Data/configuration fault. (missing CAN bus data)	Check that the correct CAN bus connector was used. If the problem persists please send log files to info@DENALIElectronics.com for analysis by DENALI

6.2 - Status Indicator Light

The CANsmart controller features a LED status indicator light, the light is located next to the micro USB programming port. The chart above defines each of the LED colors/flash patterns, and provides possible solutions to any faults that are present in the system.

6.3 - Online Trouble Shooting Guide

For the most up to date comprehensive trouble shooting guide, please visit DENALIElectronics.com/pages/denali-cansmart-canbus-controller